

## Light Bell

Ceiling Pendant Fixed Downlight

Fixture Type .....

Job Name .....

### Description

The Light Bell is a suspended general lighting luminaire for indoor mounting. Upgraded industrial chic lights - think high bay, then think again because the Light Bell is no warehouse fixture. Proportion, exquisite finish and clear purpose ring true in this stylish spin on the utilitarian classic.

Light Bell diffuser options offer elegance where low energy, high performance light is required. The shape of the reflector and opalescent diffuser were carefully prescribed to control the high output LED light engine. LED cooling is managed through the innovative pin and fin heat sink which discretely contains the integral driver.

### Lamps

LED: Bridgelux

Non Dimmable Version:

38.2W, 5244lm, 2700K, CRI 90

38.2W, 5440lm, 3000K, CRI 90

Dimmable Version:

49.5W, 6445lm, 2700K, CRI 90

49.5W, 6687lm, 3000K, CRI 90

Delivered lumens from 1248lm up to 3415lm

### Construction

Fixture contains a high efficacy technical thermoplastic diffuser.

Reflector is made from spun aluminium transparent glass or concrete model dependent.

Aluminium heat sink.

### Notes

Reflector ships separately from luminaire, must be slid over luminaire prior to being hung.

Fixture reflector sits on lamp module.

Listings: UL Listed, IP20 dry rated or IP54 damp rated, canopy model dependent.

### Electrical

Integral line voltage power supply.

Canopy to cover j-box is provided separately.

Two canopy options available: IP20 and IP54.

Available 0-10V dimming and non dimming versions.

### Photometrics

For current IES files please visit [architectural.flosusa.com](http://architectural.flosusa.com)

### Warranty

2 years from date of sale.

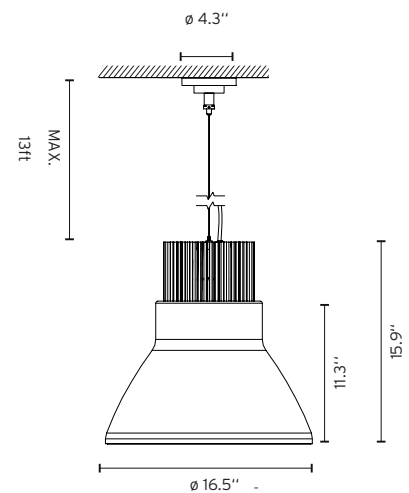
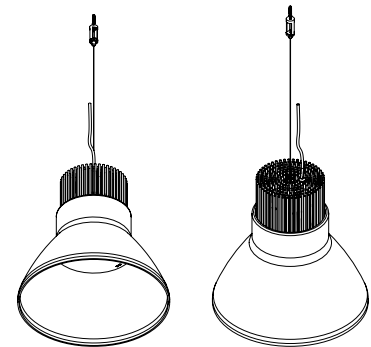

## Light Bell

Ceiling Pendant Fixed Downlight

### How to Specify

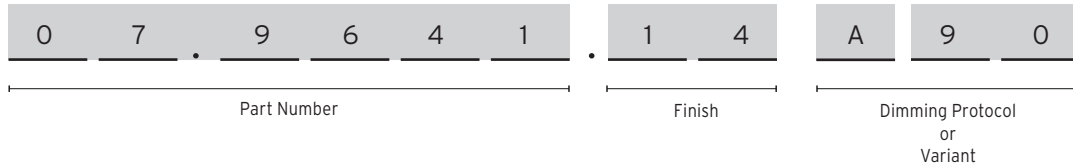

### Light Bell Light Source

QTY	CCT	CRI	Initial Lumens	Watts	Part Number	Finish	Dimming Protocol
	2700K	90	5244lm	38.2W	07.9641	■ 14 = Black	A90 = Non dimmable, 120V
	3000K	90	5440lm	38.2W	07.9642		
	2700K	90	6445lm	49.5W	07.9641	■ 14 = Black	A9V = 0-10V Dimmable, 120-277V AQF = ELV Dimmable, 120V
	3000K	90	6687lm	49.5W	07.9642		







### Light Bell Reflector

QTY	Part Number	Image	Beam Spread	Weight	Reflector Finish	
					Exterior	Interior
	07.9630.7C		78°	Weight: 0.95 Kg 2.1 lb	■ Black	■ Copper
	07.9630.70		37°	Weight: 0.95 Kg 2.1 lb	□ White	□ Anodized Aluminium
	07.9630.AN		78°	Weight: 0.95 Kg 2.1 lb	■ Black	■ Gold
	07.9630.AP		37°	Weight: 0.95 Kg 2.1 lb	■ Polished Aluminium	■ Anodized Aluminium



## Light Bell

### Ceiling Pendant Fixed Downlight

#### Light Bell Reflector

QTY	Part Number	Image	Beam Spread	Weight	Reflector Finish	
					Exterior	Interior
	07.9630.MM		78°	Weight: 0,95 Kg 2.1 lb	 Brown	 Gold
	07.9630.76		46°	Weight: 3,41 Kg 7.52 lb	 Transparent Glass	
	07.9630.CE			Weight: 4 Kg 8.82 lb	 Concrete	

#### Required Accessories

Image	QTY	Part Number	Description
		08.8775.40	4.3 " canopy for outdoors, IP54, White finish. Driver is not included, order separately
		F0556020	Power supply for standard and dimmable version IP20, Driver not included order separately