



In Vitro Bollard 1

Bollard Outdoor Light Designed by Philippe Starck

Description

Lighting outdoor collection with diffuse light for exterior ground, wall and ceiling/ suspension installation. Integral opalescent diffuser and external protection in transparent borosilicate glass. The structure is made of die-cast and extruded aluminum treated with a chemical conversion process for effective resistance to atmospheric agents. The body is powder coated and comes in various finishes. Integrated LED light source with Edge Lighting optical technology to guarantee perfect light uniformity. Integral 120V ON/OFF or 0-10V dimmable electrical power supply. The bollard version can be installed on any floor with anchors. Required Box accessory for concrete installation on ground to be order separately.



Dimensions

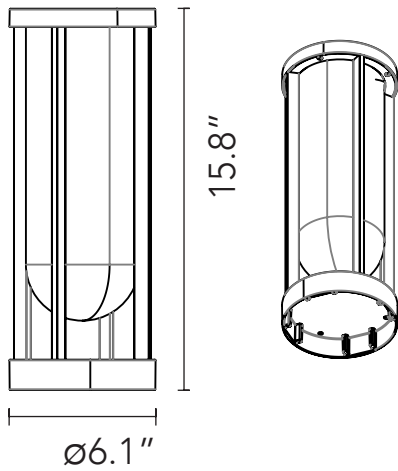

Lamp

Lamp Type	LED - Edge Lighting
Wattage	11W
Output Nominal	1150lm, 1230lm
Color Temperature	2700K, 3000K
Color rendering	CRI 80

Optical

Beam Angle	111°
Lighting Type	Direct
Light Distribution	Symmetric

Physical

Material	Aluminum / Glass
Aiming	Fixed
Weight	2.2 Lbs
Ingress Protection Rating	IP66

Finishes	Painted lacquer
----------	-----------------

- 01 White
- 33 Anthracite
- 30 Black
- 18 Deep Brown
- 12 Forest Green
- 25 Terracotta
- 13 Pale Green

Installation type	Ground
Environment	Outdoor, Wet location
Impact protection	IK10 Top / IK03 Glass

Certifications



Photometrics

For current IES files please visit arch.flosusa.com

Warranty

2 years from date of sale.



In Vitro Bollard 1

Bollard Outdoor Light Designed by Philippe Starck



Electrical & Control

Voltage	120V
Control	Non Dimmable, 0-10V Dimmable
Driver	Integral

Performance

Maximum delivered output	714lm
Efficacy	64.9lm/W

Dimensions

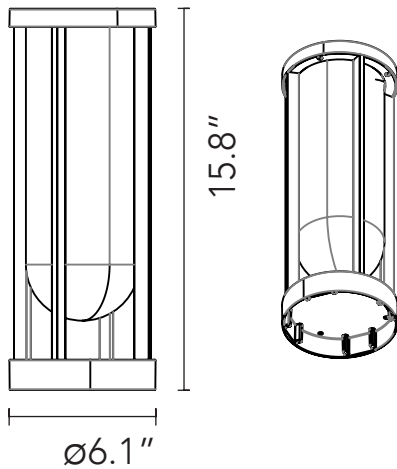

Notes

- Recommended connections for in-ground installations with a 2-way terminal block 4-pole IP68 water stop on 24V side. Order separately.
- Painted versions are an exterior rated epoxy polyester powder coat finish for superior strength, heat and UV resistance.
- During installation and maintenance avoid scratching or damaging the finish as it may result in premature corrosion of metal surfaces. Avoid cleaning fixtures with corrosive chemicals as it may result in voiding the warranty.
- Pole IP68 water stop on 24V side. Order separately.
- Recommended connections for in-ground installations with a 2-way terminal block 4-pole IP68 water stop on 24V side. Order separately.
- LED fixtures are highly susceptible to failure due to electrical effects from poor connections, and electrical short circuits. These are frequently caused by (a) overvoltage from primary voltage sources, (b) electrostatic discharge from the exterior environment. Ensure that all outdoor fixtures are installed on GFI circuits as required by code, and use proper surge protecting devices to avoid irreversible damages to electrical components.

Certifications



Photometrics

For current IES files please visit arch.flosusa.com















Warranty

2 years from date of sale.

In Vitro Bollard 1

Bollard Outdoor Light Designed by Philippe Starck

Specifications















CCT	CRI	Wattage	Initial Lumens	Part Number	Finish	Power Supply
2700K	80	11W	1150lm	F018A21AU01	 01 White	Integral Not dimmable LED driver UL
				F018A21AU12	 12 Forest Green	
				F018A21AU25	 25 Terracotta	
				F018A21AU13	 13 Pale Green	
				F018A21AU30	 30 Black	
				F018A21AU18	 18 Deep Brown	
				F018A21AU33	 33 Anthracite	
3000K	80	11W	1230lm	F018A31AU01	 01 White	Integral Not dimmable LED driver UL
				F018A31AU12	 12 Forest Green	
				F018A31AU25	 25 Terracotta	
				F018A31AU13	 13 Pale Green	
				F018A31AU30	 30 Black	
				F018A31AU18	 18 Deep Brown	
				F018A31AU33	 33 Anthracite	

In Vitro Bollard 1

Bollard Outdoor Light Designed by Philippe Starck

How to Specify

ex. F018C25BU01

CCT	CRI	Wattage	Initial Lumens	Part Number	Finish	Power Supply
2700K	80	11W	1150lm	F018A21BU01	 01 White	Integral 0-10V LED driver UL
				F018A21BU12	 12 Forest Green	
				F018A21BU25	 25 Terracotta	
				F018A21BU13	 13 Pale Green	
				F018A21BU30	 30 Black	
				F018A21BU18	 18 Deep Brown	
				F018A21BU33	 33 Anthracite	
3000K	80	11W	1474lm	F018A31BU01	 01 White	Integral 0-10V LED driver UL
				F018A31BU12	 12 Forest Green	
				F018A31BU25	 25 Terracotta	
				F018A31BU13	 13 Pale Green	
				F018A31BU30	 30 Black	
				F018A31BU18	 18 Deep Brown	
				F018A31BU33	 33 Anthracite	

In Vitro Bollard 1

Bollard Outdoor Light Designed by Philippe Starck

Accessories

IN VITRO Box for ground installation housing

Part Number:
F018Z000000

